

2020-111

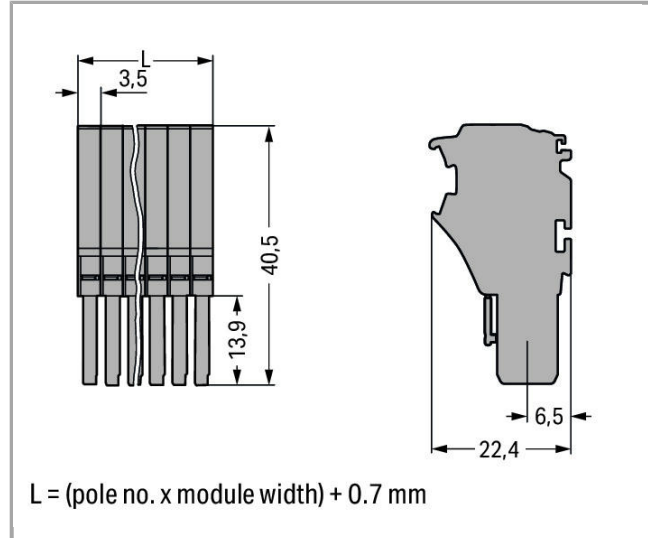
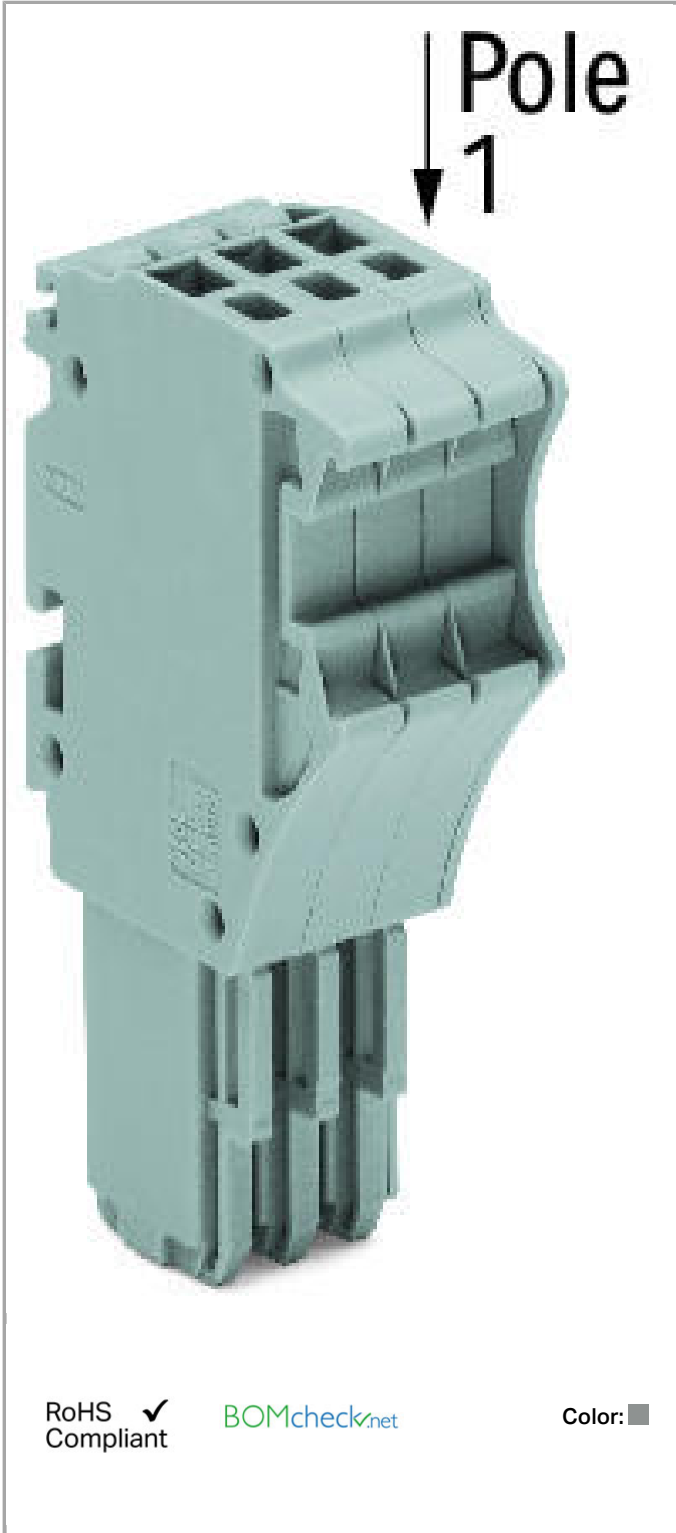

Item description

According to EN 61984, pluggable connectors without current interrupting capacity shall not be mated and unmated when live or under load.

Data

Electrical data

Ratings per IEC/EN 60664-1

Rated voltage (III / 3)	500 V
Rated impulse voltage (III / 3)	6 kV
Rated current	13.5 A

Approvals per UL 1059

Rated voltage UL (Use Group B)	300 V
Rated current UL (Use Group B)	15 A
Rated voltage UL (Use Group C)	300 V
Rated current UL (Use Group C)	15 A
Rated voltage UL (Use Group D)	300 V
Rated current UL (Use Group D)	15 A

Approvals per CSA

Rated voltage CSA (Use Group B)	300 V
Rated current CSA (Use Group B)	10 A
Rated voltage CSA (Use Group C)	300 V
Rated current CSA (Use Group C)	10 A

Connection data

Connection technology	Push-in CAGE CLAMP®
Actuation type	Open Tool Slot Push-in
Connectable conductor materials	Copper
Nominal cross section	1 mm ²
Solid conductor	0.14 ... 1.5 mm ² / 24 ... 16 AWG
Solid conductor, push-in termination	0.5 ... 1.5 mm ² / 20 ... 16 AWG
Fine-stranded conductor	0.14 ... 1.5 mm ² / 24 ... 16 AWG
Strip length	9 ... 11 mm / 0.35 ... 0.43 inch
Note (conductor cross-section)	Depending on the conductor characteristic, a conductor with a smaller cross section can also be inserted via push-in termination.
No. of poles	11

Total number of connection points	11
Total number of potentials	11
Type of wiring	Front-entry wiring

Geometrical Data

Width	39.2 mm / 1.543 inch
Height	40.5 mm / 1.594 inch
Depth	22.4 mm / 0.882 inch
Module width	3.5 mm / 0.138 inch

Mechanical data

Marking level	Side marking
---------------	--------------

Plug connection

Contact type (pluggable connector)	Female connector/socket
Connector connection type	for conductors

Material Data



Color	gray
Insulating material	Polyamide 66 (PA 66)
Fire load	0.442 MJ
Weight	24.89 g

Commercial data

Product Group	18 (X-COM-System)
Country of origin	DE
GTIN	4045454853631
Customs Tariff No.	85366990990

Approvals / Certificates

Country specific Approvals

Logo	Approval	Additional Approval Text	Certificate name
	CCA DEKRA Certification B.V.	EN 60947	NTR NL 7617
	CSA DEKRA Certification B.V.	C22.2 No. 158	2516073





CSA
DEKRA Certification B.V.



C22.2 No. 158

2516073

Ship Approvals



Logo	Approval	Additional Approval Text	Certificate name
	ABS American Bureau of Shipping	EN 60947	14- HG1293677- PDA
	BV Bureau Veritas S.A.	EN 60947	38586/A0 BV

UL-Approvals

Logo	Approval	Additional Approval Text	Certificate name
	UL UL International Germany GmbH	UL 1059	E45172
	UL Underwriters Laboratories Inc.	UL 1059	E45172

















Compatible products









tools

	Item no.: 210-647 Operating tool with partially insulated shaft; Blade (2.5 x 0.4) mm; short	210-647
	Item no.: 210-648 Operating tool with partially insulated shaft; Blade (2.5 x 0.4) mm; short; angled	210-648
	Item no.: 210-719 Operating tool with partially insulated shaft; Type 1, blade (2.5 x 0.4) mm	210-719

Locking lever

	Item no.: 2022-141 Locking lever; can be snapped on 1-conductor female plugs; for 1-pole female plugs	2022-141
--	---	----------

	Item no.: 2022-142 Locking lever; can be snapped on 1-conductor female plugs; for 1-pole female plugs	2022-142
	Item no.: 2022-151 Locking lever; can be snapped on 1-conductor female plugs; 2 poles and more	2022-151
	Item no.: 2022-152 Locking lever; can be snapped on 1-conductor female plugs; 2 poles and more	2022-152
Marking accessories		
	Item no.: 2009-110 Marking strips; on reel; not stretchable; plain; snap-on type	2009-110
	Item no.: 2009-113 WMB-Inline; for Smart Printer; on reel; plain; snap-on type	2009-113
	Item no.: 2009-113/000-002 WMB-Inline; for Smart Printer; on reel; plain; snap-on type	2009-113 /000-002
	Item no.: 2009-113/000-005 WMB-Inline; for Smart Printer; on reel; plain; snap-on type	2009-113 /000-005
	Item no.: 2009-113/000-006 WMB-Inline; for Smart Printer; on reel; plain; snap-on type	2009-113 /000-006
	Item no.: 2009-113/000-007 WMB-Inline; for Smart Printer; on reel; plain; snap-on type	2009-113 /000-007
	Item no.: 2009-113/000-012 WMB-Inline; for Smart Printer; on reel; plain; snap-on type	2009-113 /000-012
	Item no.: 2009-113/000-017 WMB-Inline; for Smart Printer; on reel; plain; snap-on type	2009-113 /000-017
	Item no.: 2009-113/000-023 WMB-Inline; for Smart Printer; on reel; plain; snap-on type	2009-113 /000-023
	Item no.: 2009-113/000-024 WMB-Inline; for Smart Printer; on reel; plain; snap-on type	2009-113 /000-024
	Item no.: 210-831 Marking strips; on reel; 2.3 mm wide; plain; Self-adhesive	210-831
	Item no.: 210-832 Marking strips; on reel; 3 mm wide; plain; Self-adhesive	210-832
	Item no.: 210-833 Marking strips; on reel; 6 mm wide; plain; Self-adhesive	210-833
	Item no.: 210-834 Marking strips; on reel; 5 mm wide; plain; Self-adhesive	210-834

	Item no.: 793-3501 WMB marking card; as card; plain; snap-on type	793-3501
ferrule		
	Item no.: 216-241 Ferrule; Sleeve for 0.5 mm ² / 20 AWG; insulated; electro-tin plated; electrolytic copper; gastight crimped; acc. to DIN 46228, Part 4/09.90	216-241
	Item no.: 216-242 Ferrule; Sleeve for 0.75 mm ² / 18 AWG; insulated; electro-tin plated; electrolytic copper; gastight crimped; acc. to DIN 46228, Part 4/09.90	216-242
	Item no.: 216-243 Ferrule; Sleeve for 1 mm ² / AWG 18; insulated; electro-tin plated; electrolytic copper; gastight crimped; acc. to DIN 46228, Part 4/09.90	216-243
Strain relief plate		
	Item no.: 734-326 Strain relief plate	734-326
	Item no.: 734-430 Strain relief plate	734-430
	Item no.: 734-431 Strain relief plate	734-431
Protective Warning Marker		
	Item no.: 2000-115 Protective warning marker; with high-voltage symbol, black; for 5 terminal blocks	2000-115

Downloads**Documentation****Bid Text**

2020-111	docx 15.4 kB	Download
----------	-----------------	----------

Additional Information

pdf 2.1 MB	Download
---------------	----------

CAD/CAE - Smart Data**CAD data**

3D Download 2020-111	URL	Download
----------------------	-----	----------



Product family

X-COM S-Mini

Show all products from the family

Subject to changes.
